	Product Information CDM10-10	Manufacturer	Nanfeng Pump Industry Co.,Ltd (CNP)
		Address	Hangzhou, Zhejiang, China
		Contact	86-571-88637351
		Date	2025/07/08
Project Name		Client Name	WEPKO
Item NO		Client Addr.	
		Contacts	Wepko
		Contact	

Part NO.	1100090748
----------	------------

Product Picture: (Note: Images may not be the same as the product)	Note
	<p>CDM/CDMF pumps are new generation, high efficiency, non-self-priming vertical multistage centrifugal pumps (Abbr. as pumps). It referred to European standard, adopted entirely new industrial design, efficiency achieved $MEI \geq 0.7$. It is energy saving, low noise, environment friendly, compact design, beautiful shape, light weight, easy for service, high reliability.</p>

Nameplate parameters

Flow	10 m ³ /h
Head	89 m
Efficiency	72 %
Speed	2900 rpm
Number of stages	10

Technology

Pump rotator speed	2900
Nameplate standards	CE
Pump version	2

Material

Impeller	304
Rubber code	P
Inlet&outlet chamber	304
Material Code	S

Installation

Connection Code	F
Maximum Pressure/Temperature (high temperature)	25 bar / 120 °C
Maximum Pressure/Temperature (low temperature)	25 bar / -15 °C
Flange Standard	DIN
Pressure Class	PN25
Inlet & outlet	DN40

Medium

Medium Temperature normal temperature	-15°C+70°C
Medium Temperature high temperature	-15°C+120°C
Maximum Environment Temperature	40°C

Structure dimension

Model picture	F
Expolded view	CDMF10exploded view

 CNP 南方泵业	Product Information CDM10-10	Manufacturer	Nanfang Pump Industry Co.,Ltd (CNP)
		Address	Hangzhou, Zhejiang, China
		Contact	86-571-88637351
		Date	2025/07/08
Project Name		Client Name	WEPKO
		Client Addr.	
Item NO		Contacts	Wepko
		Contact	

Motor

Number of Motor Phase	Three Phase
Protection Class	IP55
Insulation Class	F
Motor Power(kW)	4KW
Power Frequency(Hz)	50Hz
Rated Voltage (V)	380V
Rated Current (A)	7.8A
Energy Efficiency Level	IE3

Seal

Mechanical Seal	CDLA-16/WB1F14
-----------------	----------------

Others

Weight (kg)	64
-------------	----

	Performance Curve CDM10-10	Manufacturer	Nanfeng Pump Industry Co.,Ltd (CNP)
		Address	Hangzhou, Zhejiang, China
		Contact	86-571-88637351
		Date	2025/07/08
Project Name		Client Name	WEPKO
Item NO		Client Addr.	
		Contacts	Wepko
		Contact	

The hydraulic performance curve have been tested with water at 20°C, density 1000kg/m³,and at 1bar atmospherical pressure. ISO99062012 Grade 3B

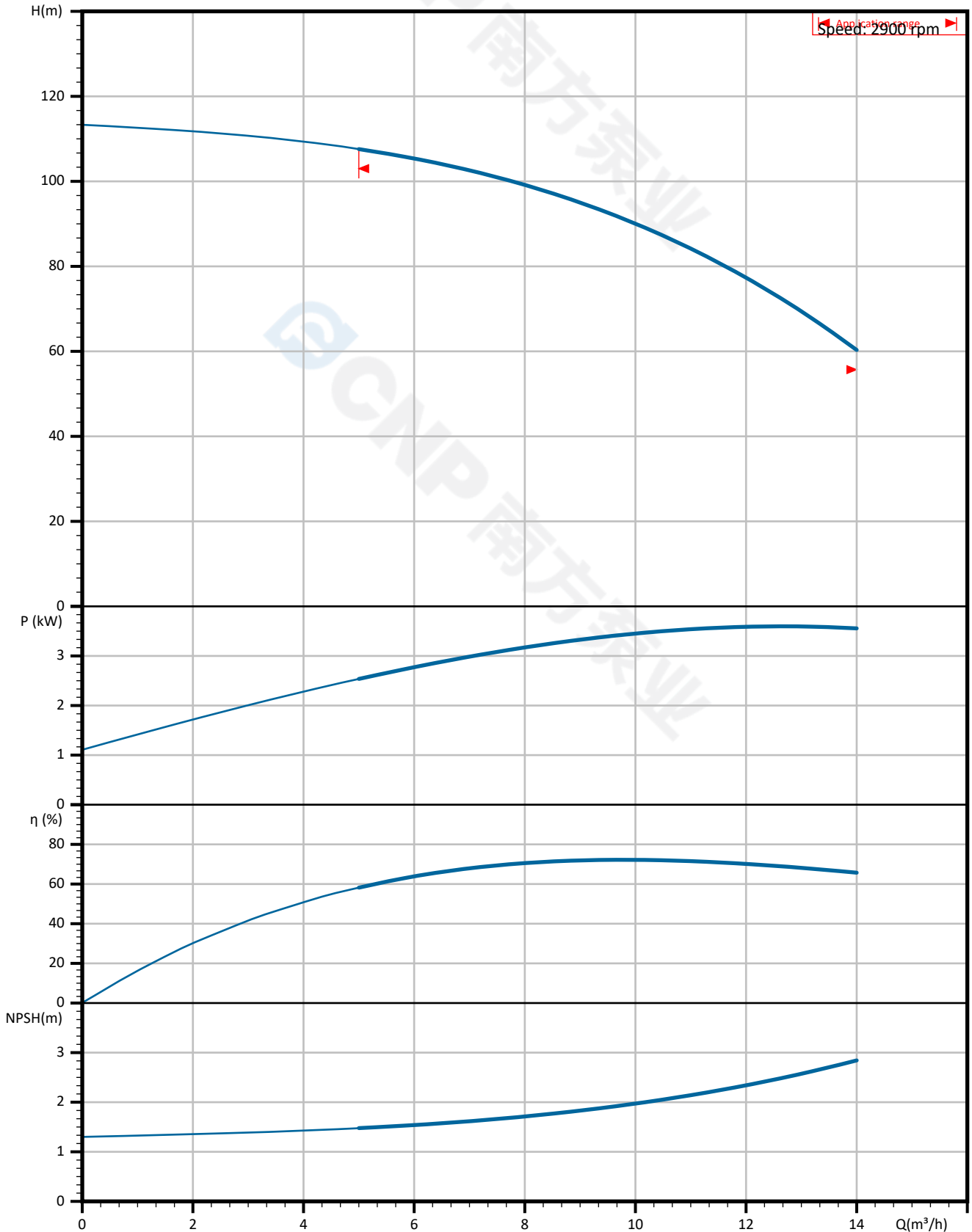



Pump Technical Parameters

CDM10-10

Manufacturer	Nanfang Pump Industry Co.,Ltd (CNP)
Address	Hangzhou, Zhejiang, China
Contact	86-571-88637351
Date	2025/07/08
Client Name	WEPKO
Client Addr.	
Contacts	Wepko
Contact	

Rated parameters	
Pump model	CDM10-10
Part NO.	1100090748
Rated flow	10 m ³ /h
Rated head	89 m
Rated efficiency	72 (%)
Power (kW)	3.37 kW
NPSHr (m)	2
Speed (rpm)	2900
Max impeller diameter (mm)	100
Medium	
Pumped medium	water
Working temperature (°C)	20
Medium density (kg/m ³)	1000
Viscosity (mm ² /s)	1

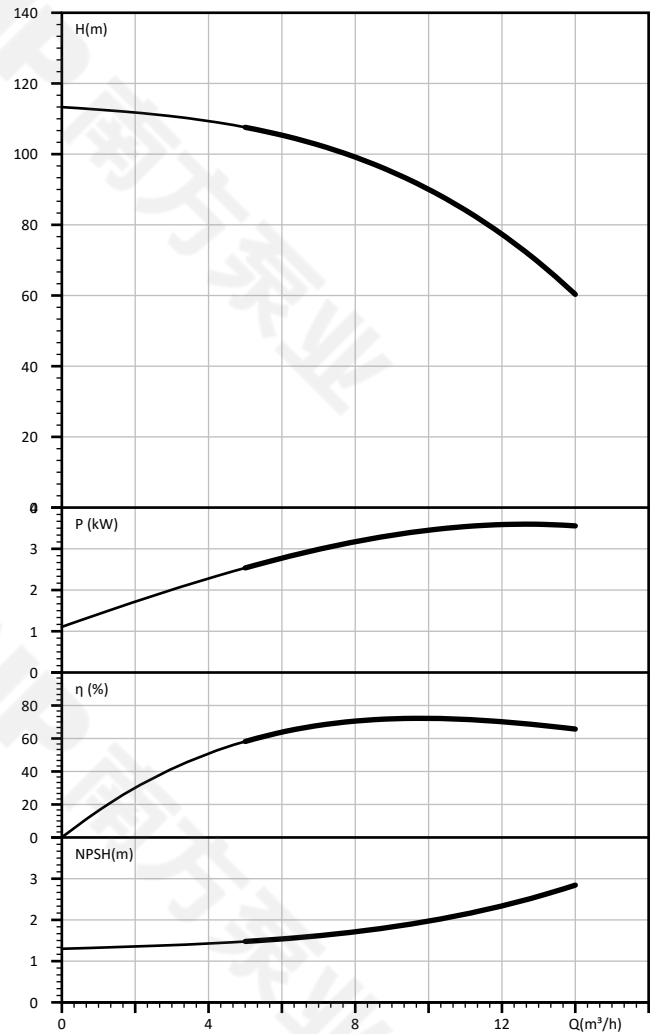

Dimension Drawing
CDM10-10

Manufacturer	Nanfeng Pump Industry Co.,Ltd (CNP)
Address	Hangzhou, Zhejiang, China
Contact	86-571-88637351
Date	2025/07/08
Client Name	WEPKO
Client Addr.	
Contacts	Wepko
Contact	

Project Name

Item NO

CDMF10-10 50Hz

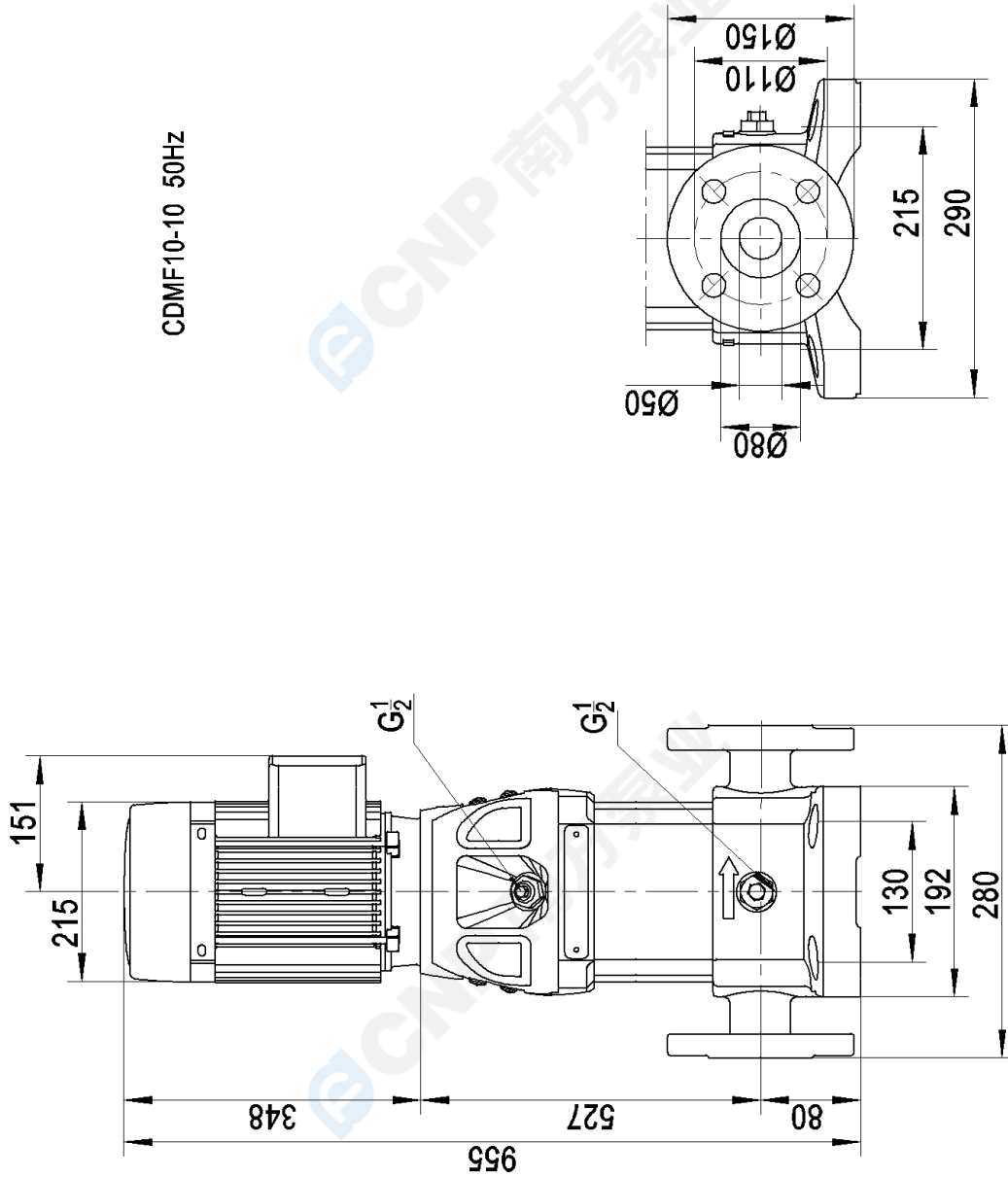

Explosed view
CDM10-10

Manufacturer	Nanfeng Pump Industry Co.,Ltd (CNP)
Address	Hangzhou, Zhejiang, China
Contact	86-571-88637351
Date	2025/07/08
Client Name	WEPKO
Client Addr.	
Contacts	Wepko
Contact	

Project Name	
Item NO	

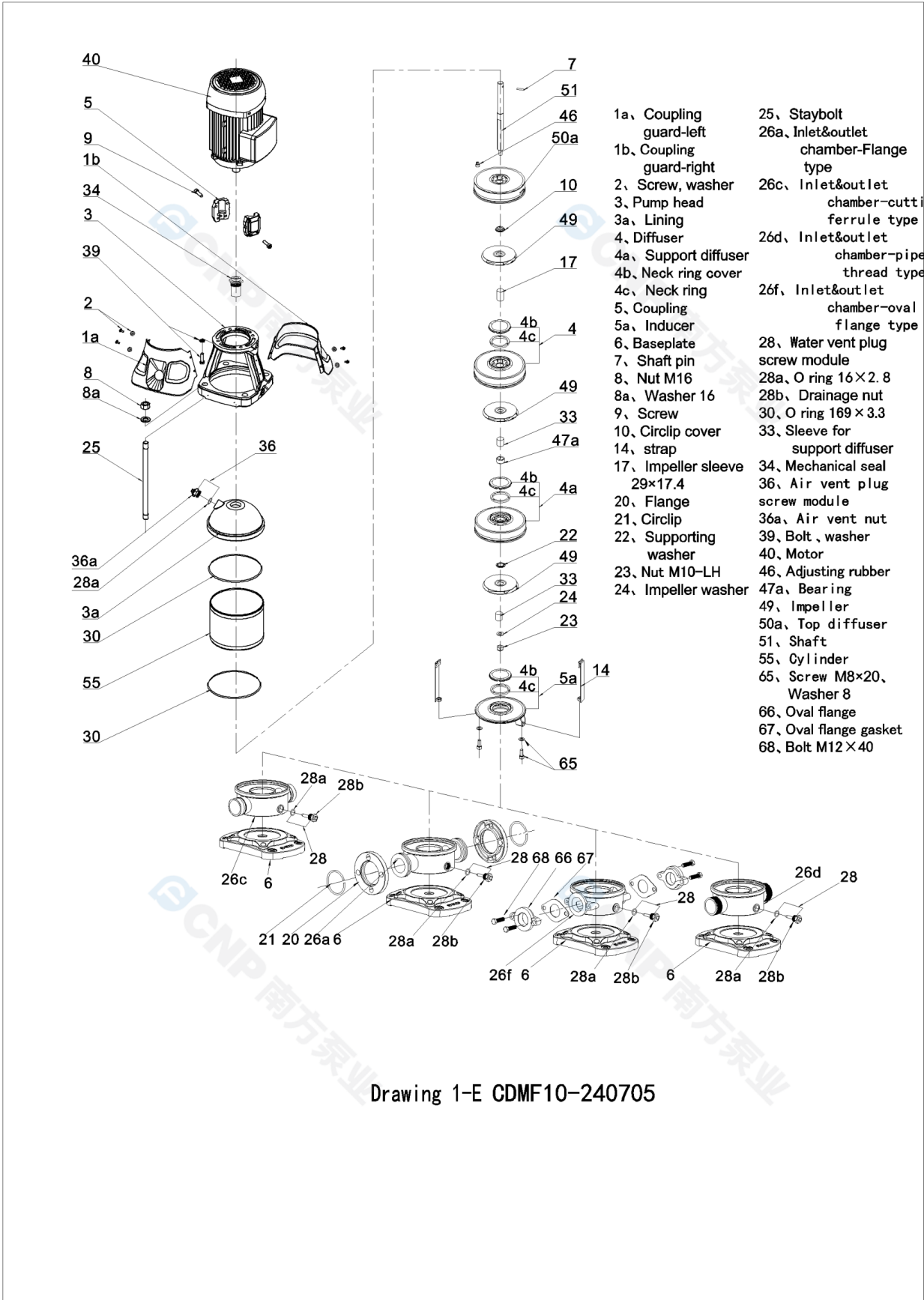

Drawing 1-E CDMF10-240705

	Physical picture CDM10-10	Manufacturer	Nanfang Pump Industry Co.,Ltd (CNP)
		Address	Hangzhou, Zhejiang, China
		Contact	86-571-88637351
		Date	2025/07/08
		Client Name	WEPKO
Project Name		Client Addr.	
Item NO		Contacts	Wepko
		Contact	



	Order Data CDM10-10	Manufacturer	Nanfeng Pump Industry Co.,Ltd (CNP)
		Address	Hangzhou, Zhejiang, China
		Contact	86-571-88637351
		Date	2025/07/08
		Client Name	WEPKO
Project Name		Client Addr.	
Item NO		Contacts	Wepko
		Contact	

Pump model CDM10-10
 Part NO. 1100090748
 Product price
 Quantity 1
 Total price

Inquiry notes