	Product Information CDM15-16	Manufacturer	Nanfang Pump Industry Co.,Ltd (CNP)
		Address	Hangzhou, Zhejiang, China
		Contact	86-571-88637351
		Date	2025/07/08
Project Name		Client Name	WEPKO
Item NO		Client Addr.	
		Contacts	
		Contact	

Part NO.	1100090775
----------	------------

Product Picture: (Note: Images may not be the same as the product)	Note
	<p>CDM/CDMF pumps are new generation, high efficiency, non-self-priming vertical multistage centrifugal pumps (Abbr. as pumps). It referred to European standard, adopted entirely new industrial design, efficiency achieved $MEI \geq 0.7$. It is energy saving, low noise, environment friendly, compact design, beautiful shape, light weight, easy for service, high reliability.</p>

Nameplate parameters

Flow	15 m ³ /h
Head	189 m
Efficiency	71 %
Speed	2900 rpm
Number of stages	16

Technology

Pump rotator speed	2900
Nameplate standards	CE
Pump version	2

Material

Impeller	304
Rubber code	P
Inlet&outlet chamber	304
Material Code	S

Installation

Connection Code	F
Maximum Pressure/Temperature (high temperature)	25 bar / 120 °C
Maximum Pressure/Temperature (low temperature)	25 bar / -15 °C
Flange Standard	DIN
Pressure Class	PN25
Inlet & outlet	DN50

Medium

Medium Temperature normal temperature	-15°C+70°C
Medium Temperature high temperature	-15°C+120°C
Maximum Environment Temperature	40°C

Structure dimension

Model picture	F
Expolded view	CDMF15,20exploded view

 CNP 南方泵业	Product Information CDM15-16	Manufacturer	Nanfang Pump Industry Co.,Ltd (CNP)
		Address	Hangzhou, Zhejiang, China
		Contact	86-571-88637351
		Date	2025/07/08
Project Name		Client Name	WEPKO
		Client Addr.	
Item NO		Contacts	
		Contact	

Motor

Number of Motor Phase	Three Phase
Protection Class	IP55
Insulation Class	F
Motor Power(kW)	15KW
Power Frequency(Hz)	50Hz
Rated Voltage (V)	380V
Rated Current (A)	27.9A
Energy Efficiency Level	IE3

Seal

Mechanical Seal	CDLA-16/WB1F14
-----------------	----------------

Others

Weight (kg)	173
-------------	-----

 CNP 南方泵业	Performance Curve CDM15-16	Manufacturer	Nanfang Pump Industry Co.,Ltd (CNP)
		Address	Hangzhou, Zhejiang, China
		Contact	86-571-88637351
		Date	2025/07/08
Project Name		Client Name	WEPKO
Item NO		Client Addr.	
		Contacts	
		Contact	

The hydraulic performance curve have been tested with water at 20°C, density 1000kg/m³,and at 1bar atmospherical pressure. ISO99062012 Grade 3B

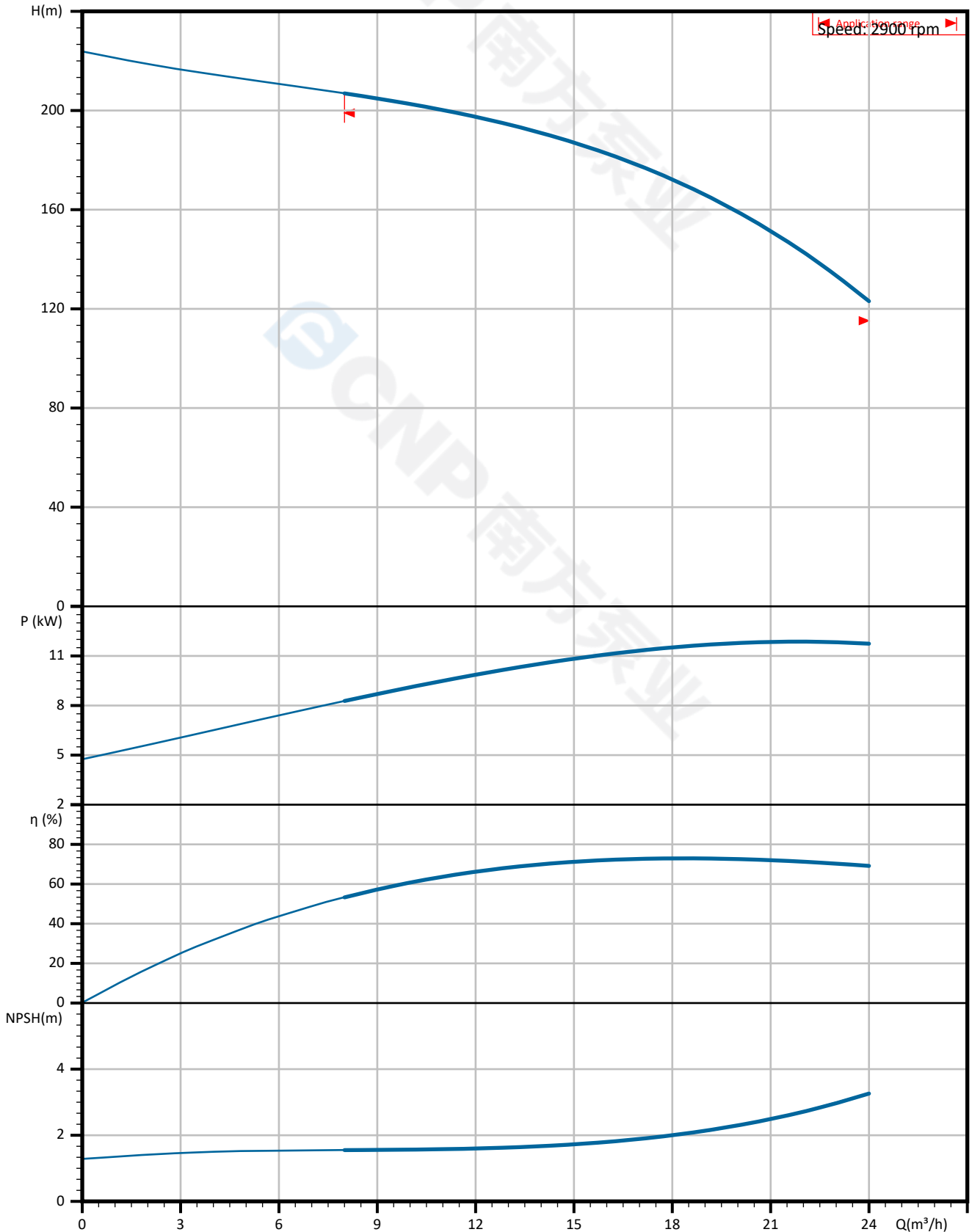





Pump Technical Parameters

CDM15-16

Manufacturer	Nanfang Pump Industry Co.,Ltd (CNP)
Address	Hangzhou, Zhejiang, China
Contact	86-571-88637351
Date	2025/07/08
Client Name	WEPKO
Client Addr.	
Contacts	
Contact	

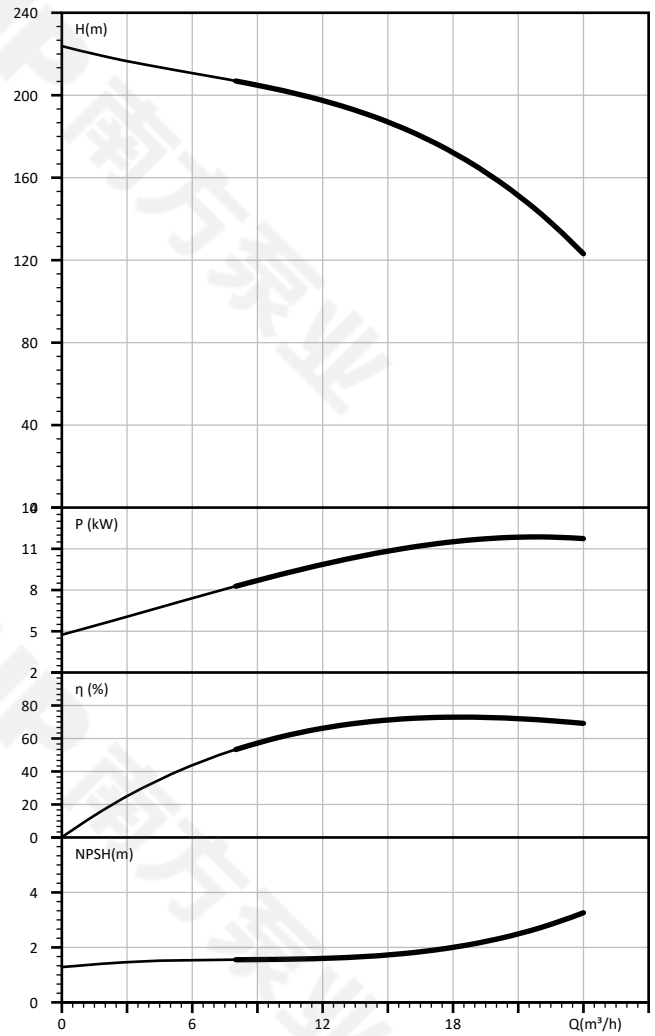
Rated parameters	
Pump model	CDM15-16
Part NO.	1100090775
Rated flow	15 m ³ /h
Rated head	189 m
Rated efficiency	71 (%)
Power (kW)	10.9 kW
NPSHr (m)	1.8
Speed (rpm)	2900
Max impeller diameter (mm)	105
Medium	
Pumped medium	water
Working temperature (°C)	20
Medium density (kg/m ³)	1000
Viscosity (mm ² /s)	1



	Dimension Drawing CDM15-16	Manufacturer	Nanfeng Pump Industry Co.,Ltd (CNP)
		Address	Hangzhou, Zhejiang, China
		Contact	86-571-88637351
		Date	2025/07/08
Project Name		Client Name	WEPKO
Item NO		Client Addr.	
		Contacts	
		Contact	

CDMF15-16 50HZ

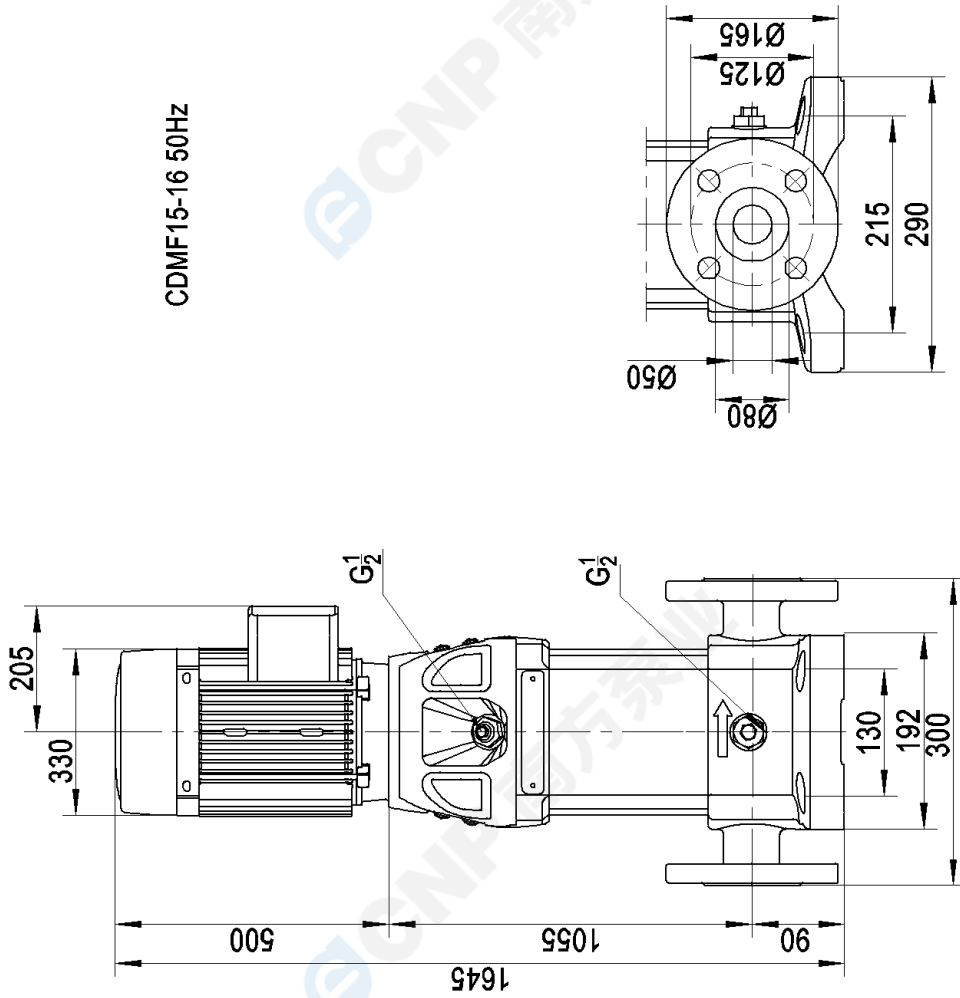

Exploided view
CDM15-16

Manufacturer	Nanfeng Pump Industry Co.,Ltd (CNP)
Address	Hangzhou, Zhejiang, China
Contact	86-571-88637351
Date	2025/07/08
Client Name	WEPKO
Client Addr.	
Contacts	
Contact	

Project Name

Item NO

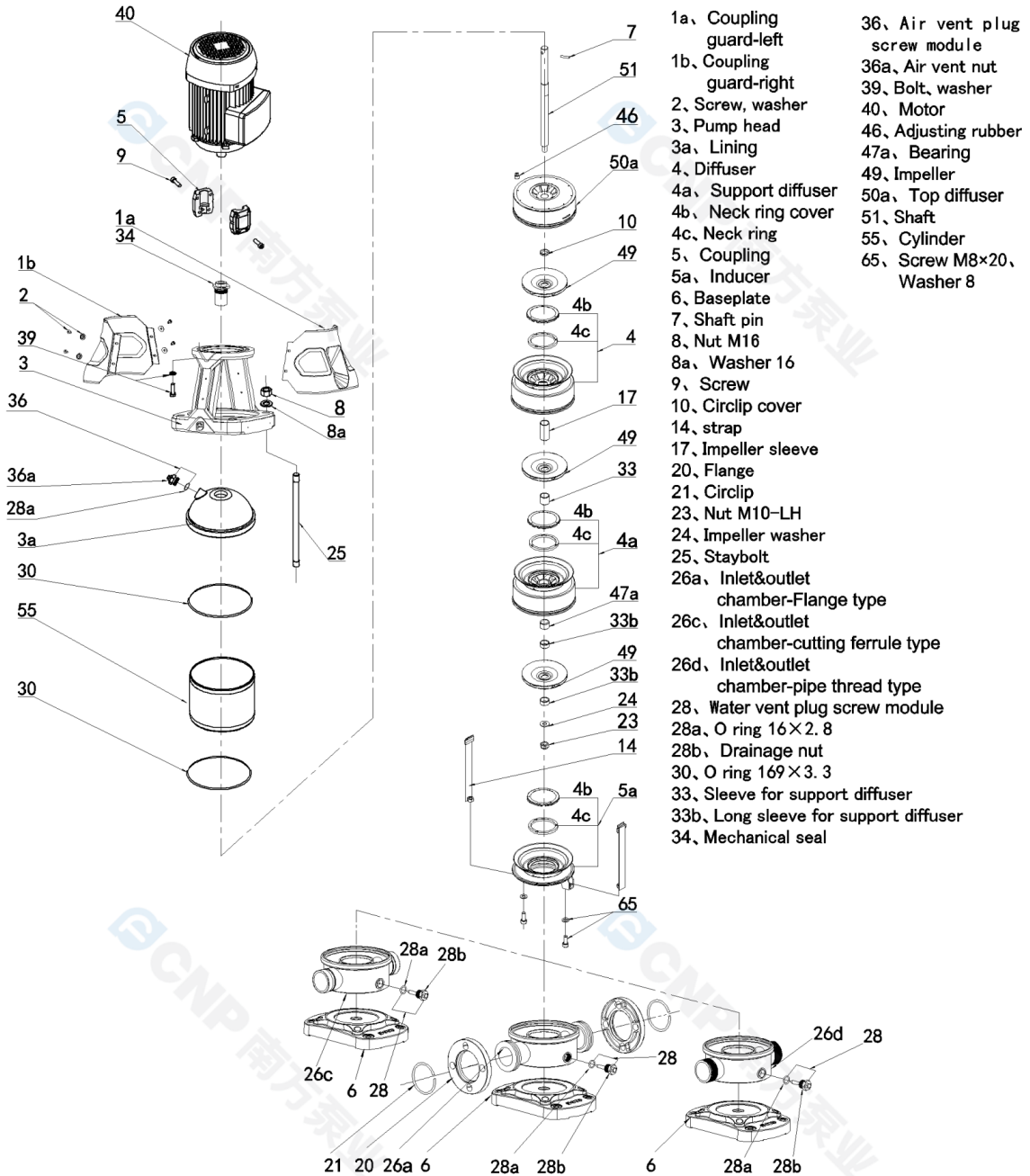

Drawing 1-G CDMF15, 20-240705

	Physical picture CDM15-16	Manufacturer	Nanfang Pump Industry Co.,Ltd (CNP)
		Address	Hangzhou, Zhejiang, China
		Contact	86-571-88637351
		Date	2025/07/08
		Client Name	WEPKO
Project Name		Client Addr.	
Item NO		Contacts	
		Contact	



	Order Data CDM15-16	Manufacturer	Nanfeng Pump Industry Co.,Ltd (CNP)
		Address	Hangzhou, Zhejiang, China
		Contact	86-571-88637351
		Date	2025/07/08
		Client Name	WEPKO
Project Name		Client Addr.	
Item NO		Contacts	
		Contact	

Pump model CDM15-16
 Part NO. 1100090775
 Product price
 Quantity 1
 Total price

Inquiry notes