



| | | | |
|--|---|--------------|--------------------------------------|
|  | Product Information CHM15-50 | Manufacturer | CNP |
| | | Address | Yuhang District, Hangzhou, Zhejiang, |
| Project Name | | Contact | 86-571-88637351 |
| | | Date | 2022/03/07 |
| Item NO | | Client Name | DPA |
| | | Client Addr. | |
| | | Contacts | Alireza |
| | | Contact | |

| | |
|----------|------------|
| Part NO. | 1100196739 |
|----------|------------|

| Product Picture | Note |
|---|---|
|  | <p>Non-self-priming horizontal multistage centrifugal pump. The impeller guide vane is made of stainless steel plate stamping and welding. Equipped with long shaft motor, axial inlet and radial outlet.</p> |

| | |
|----------------------------|--------------|
| technology | |
| Pump rotator speed | 2900 |
| Material | |
| Impeller | 304 |
| Rubber code | F |
| Material Code | S |
| Installation | |
| Connection Code | L |
| Installation type | horizontal |
| Maximum Operation Pressure | 10Bar |
| Medium | |
| Medium Temperature normal | -15+70 |
| Medium Temperature high t | -15+105 |
| Maximum Environment Temper | 40 |
| Structure dimension | |
| Inlet & outlet size types | G |
| Inlet & Outlet Diameter | G2/G2 |
| Rotation Direction | Clockwise |
| Motor | |
| Number of Motor Phase | Three Phase |
| Protection Class | IP55 |
| Insulation Class | F |
| Motor Power | 4 |
| Energy Efficiency Level | IE3 |
| Seal | |
| Mechanical Seal | CHM-19/SB1F4 |
| Others | |
| Weight (kg) | 37 |



Performance Curve CHM15-50

| | |
|--------------|--------------------------------------|
| Manufacturer | CNP |
| Address | Yuhang District, Hangzhou, Zhejiang, |
| Contact | 86-571-88637351 |
| Date | 2022/03/07 |
| Client Name | DPA |
| Client Addr. | |
| Contacts | Alireza |
| Contact | |

Project Name

Item NO

The hydraulic performance curve have been tested with Clean Water at 20°C, density 1000kg/m³, and at 1bar atmospheric pressure. ISO99062012 Grade 3B

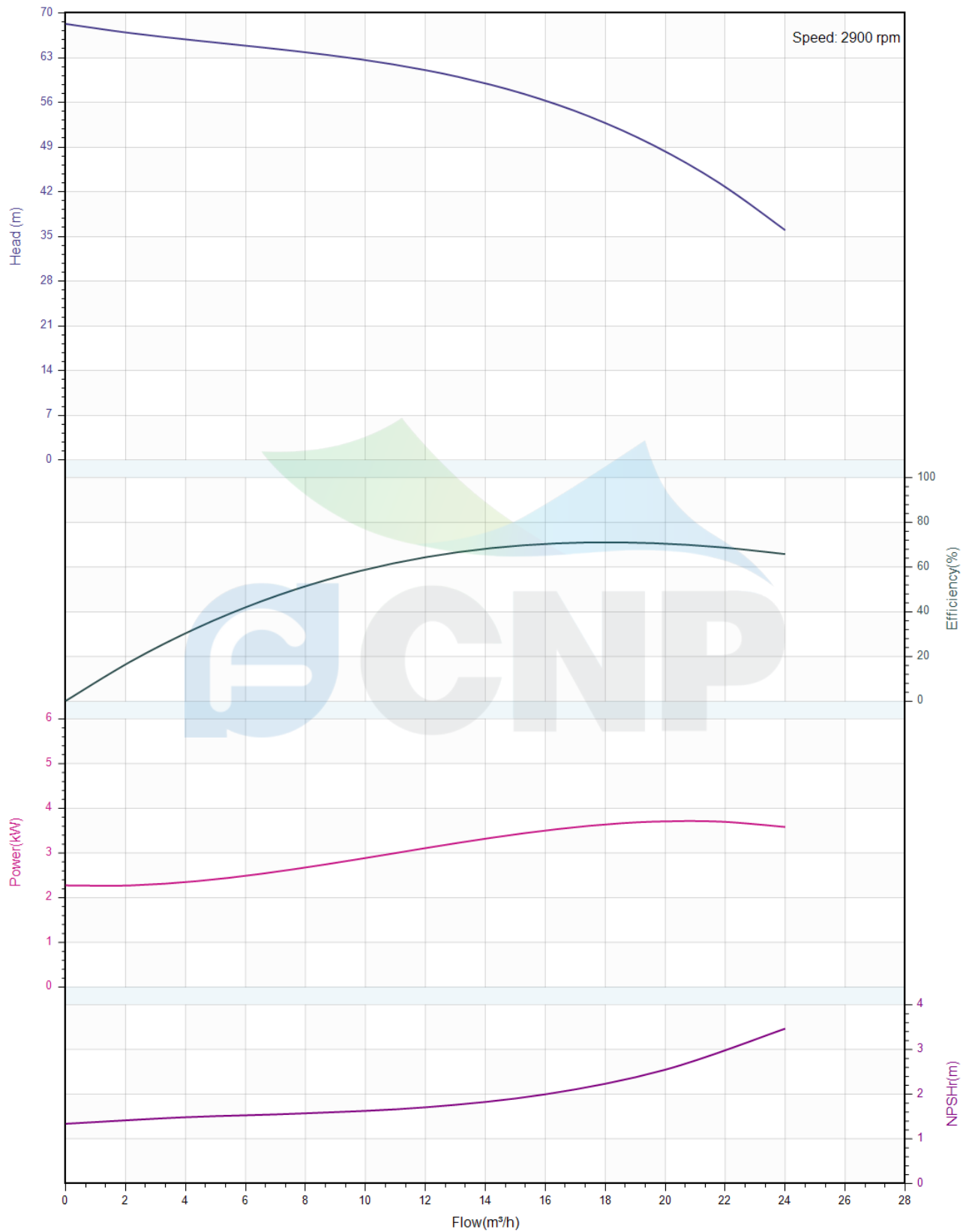



Pump Technical Parameters CHM15-50

| | |
|--------------|--------------------------------------|
| Manufacturer | CNP |
| Address | Yuhang District, Hangzhou, Zhejiang, |
| Contact | 86-571-88637351 |
| Date | 2022/03/07 |
| Client Name | DPA |
| Client Addr. | |
| Contacts | Alireza |
| Contact | |

Rated parameters

| | |
|--------------------------------|------------|
| Pump model | CHM15-50 |
| Part NO. | 1100196739 |
| Rated flow (m ³ /h) | 15 |
| Rated head (m) | 58 |
| Rated efficiency (%) | 70 |
| Power (kW) | 3.387 |
| NPSHr (m) | 1.9 |
| Speed (rpm) | 2900 |
| Max impeller diameter (mm) | 105.2 |

Medium

| | |
|-------------------------------------|-------------|
| Pumped medium | Clean Water |
| Working temperature (°C) | 20 |
| Medium density (kg/m ³) | 1000 |
| Viscosity (mm ² /s) | 1 |

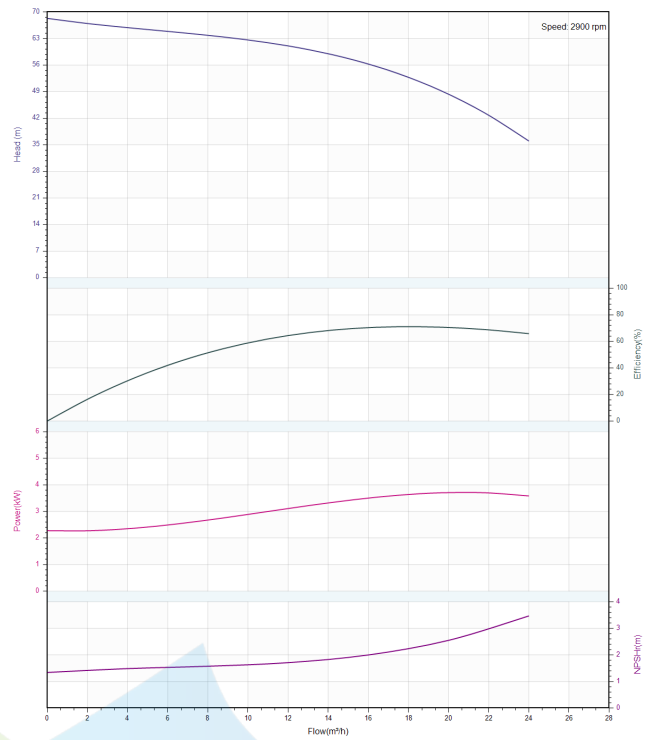

| | | | |
|--|---|--------------|--------------------------------------|
|  | Structure picture CHM15-50 | Manufacturer | CNP |
| | | Address | Yuhang District, Hangzhou, Zhejiang, |
| Project Name | | Contact | 86-571-88637351 |
| | | Date | 2022/03/07 |
| Item NO | | Client Name | DPA |
| | | Client Addr. | |
| | | Contacts | Alireza |
| | | Contact | |

CHM15_20-200801

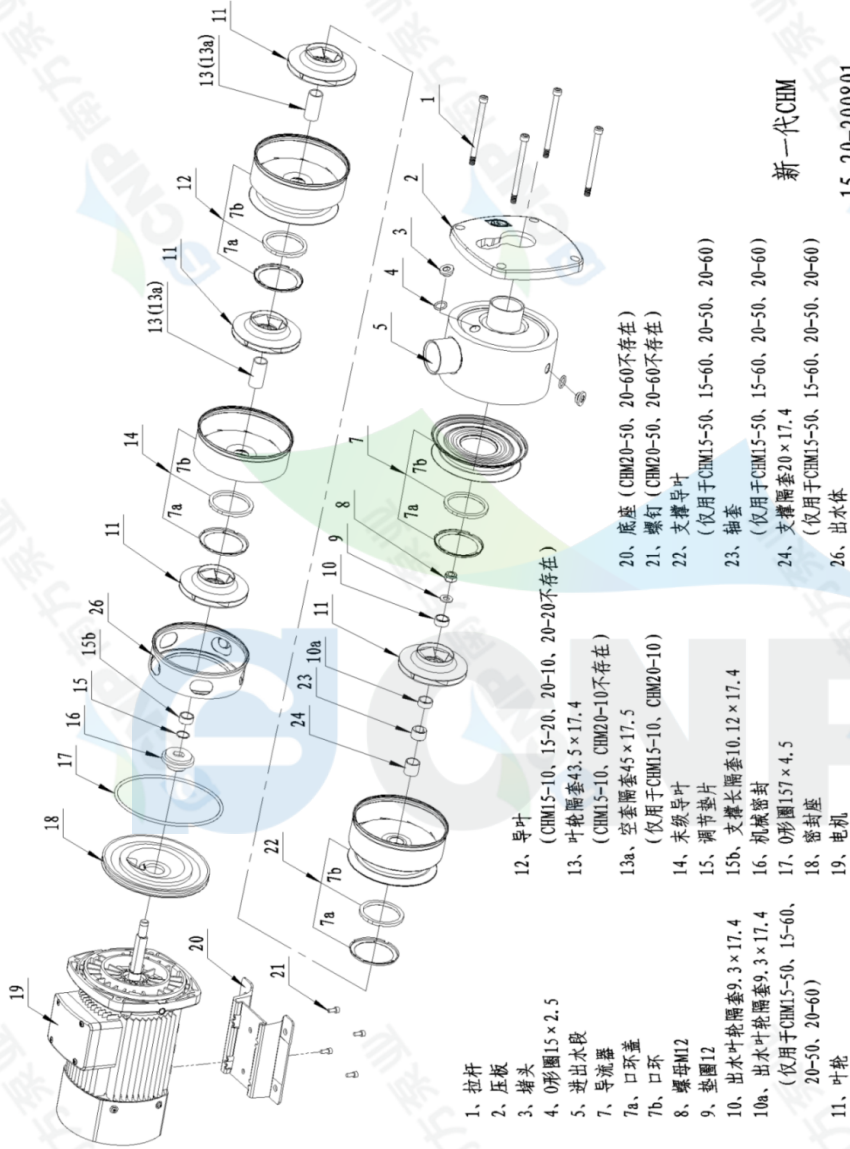

- 1、拉杆
- 2、压板
- 3、堵头
- 4、O形圈15×2.5
- 5、进出水段
- 7、导流器
- 7a、口环盖
- 7b、口环
- 8、螺母M12
- 9、垫圈12
- 10、出水叶轮隔套9.3×17.4
- 10a、出水叶轮隔套9.3×17.4 (仅用于CHM15-50、15-60、20-50、20-60)
- 11、叶轮
- 12、导叶 (CHM15-10、15-20、20-10、20-20不存在)
- 13、叶轮隔套43.5×17.4 (CHM15-10、CHM20-10不存在)
- 13a、空套隔套45×17.5 (仅用于CHM15-10、CHM20-10)
- 14、末级导叶
- 15、调节垫片
- 15b、支撑长隔套10.12×17.4
- 16、机械密封
- 17、O形圈157×4.5 (仅用于CHM15-50、15-60、20-50、20-60)
- 18、密封座
- 19、电机
- 20、底座 (CHM20-50、20-60不存在)
- 21、螺钉 (CHM20-50、20-60不存在)
- 22、支撑导叶 (仅用于CHM15-50、15-60、20-50、20-60)
- 23、轴承
- 24、支撑隔套20×17.4 (仅用于CHM15-50、15-60、20-50、20-60)
- 26、出水体

新一代CHM
15, 20-200801

| | |
|------|--|
| 制图 | |
| 审核 | |
| 旧版图号 | |
| 新版图号 | |
| 签字 | |
| 日期 | |

| | | | |
|---|-----|------------------------------|-------|
|  南方泵业 | | 爆炸图 | |
| | | 轻型卧式多级离心泵 CHM15_20-200801 | |
| 设计 | 校对 | 审核 | 工艺 |
| 日期 | 日期 | 日期 | 日期 |
| 重量 | 比例 | 共 1 页 | 第 1 页 |
| S | 1:1 | | |



Dimension Drawing CHM15-50

| | |
|--------------|--------------------------------------|
| Manufacturer | CNP |
| Address | Yuhang District, Hangzhou, Zhejiang, |
| Contact | 86-571-88637351 |
| Date | 2022/03/07 |
| Client Name | DPA |
| Client Addr. | |
| Contacts | Alireza |
| Contact | |

Project Name

Item NO

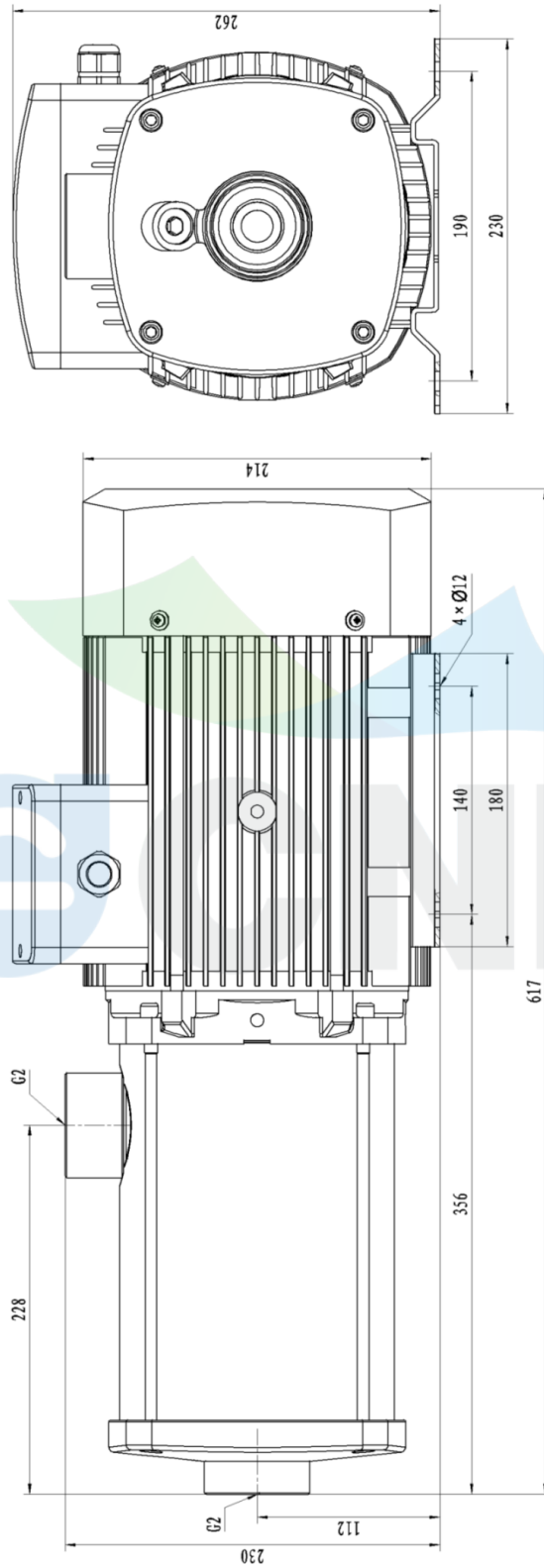

CHM15-50

| | | |
|-------------------------|----|-------|
| 南方泵业 外形图 CHM15-50 | | |
| 图样标记 | 重量 | 比例 |
| | | 1:2.5 |
| 共 1 页 | | 第 1 页 |
| 标记 | 审核 | 日期 |
| 设计 | 标准 | |
| 校对 | 审核 | |
| 制图 | 工艺 | |
| 修改文件 | 签字 | 日期 |

| | |
|------|----|
| 描图 | 日期 |
| 描图 | 日期 |
| 底图总号 | |
| 底图总号 | |
| 签字 | |
| 日期 | |